

BUXORO VILOYATIDAGI KORXONA VA TASHKILOTLAR DEMOGRAFIYASI BO‘YICHA MA‘LUMOT

2021- yil 1- may holatiga ko‘ra
(fermer va dehqon xo‘jaliklaridan tashqari)

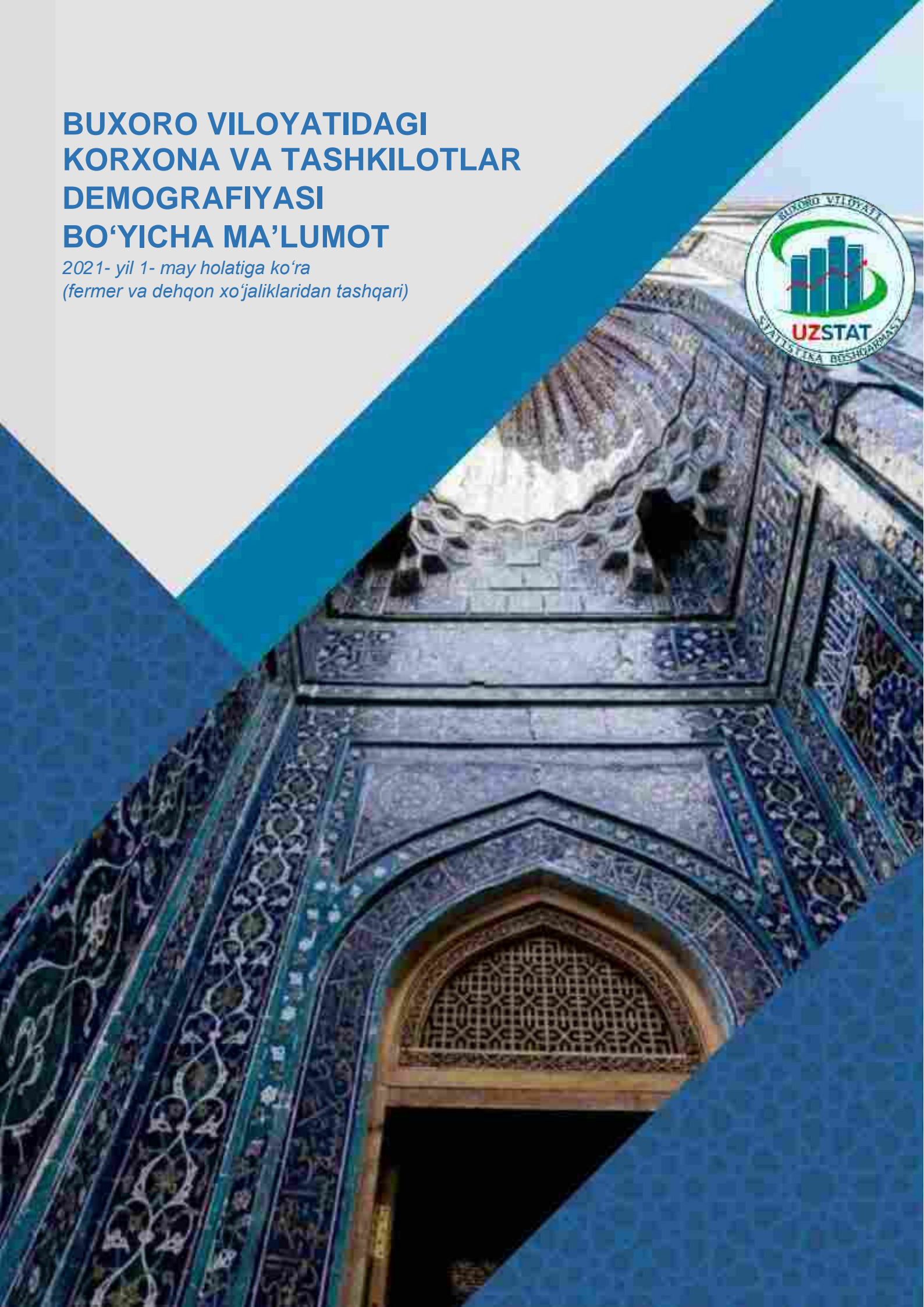

Tadbirkorlik subyektlari iqtisodiyotni rivojlantirish, aholi bandligi va daromadlarini oshirishda muhim omildir. Ushbu soha vakillarini har tomonlama qo'llab-quvvatlash maqsadida, oxirgi yillarda Prezidentimizning ko'plab farmon va qarorlari qabul qilindi.

Jumladan, tadbirkorlik faoliyatini davlat ro'yxatidan o'tkazish, turli ruxsatnomalar olish va boshqa ko'plab xizmatlar tartib-qoidalari soddalashtirildi. Bu borada qulaylik yaratish uchun Davlat xizmatlari agentligi va uning joylardagi markazlari tashkil etildi. Tadbirkorlik subyektlarining huquqlari va qonuniy manfaatlarini himoya qilish bo'yicha vakil (Biznes-ombudsman) devoni tashkil qilindi.

Barcha hududlarda tadbirkorlar murojaatlarini qabul qilib, hal etishga ko'maklashadigan Bosh vazir qabulxonalarini tashkil etildi. Vazirlar Mahkamasi huzurida Tadbirkorlik faoliyatini rivojlantirishni qo'llab-quvvatlash davlat jamg'armasi faoliyati yo'lga qo'yildi. Tijorat banklari tomonidan tadbirkorlarga ajratilayotgan kreditlar hajmi oshdi.

Oxirgi yillarda hukumatimiz tomonidan tadbirkorlik subyektlarining faoliyatini yanada rivojlantirish va barqaror faoliyat ko'rsatishini ta'minlash maqsadida yaratib berilayotgan shart-sharoitlar va qulayliklar natijasida faoliyat ko'rsatayotgan hamda yangi tashkil etilayotgan korxonalar va tashkilotlar soni yildan-yilga sezilarli ravishda oshib bormoqda.

Korxonalar va tashkilotlar to'g'risidagi mazkur ma'lumotlar O'zbekiston Respublikasi Adliya vazirligi huzuridagi Davlat xizmatlari agentligi ma'lumotlar bazasi asosida, 2021-yil 1-may holatiga ko'ra (fermer va dehqon xo'jaliklarisiz) shakllantirildi.

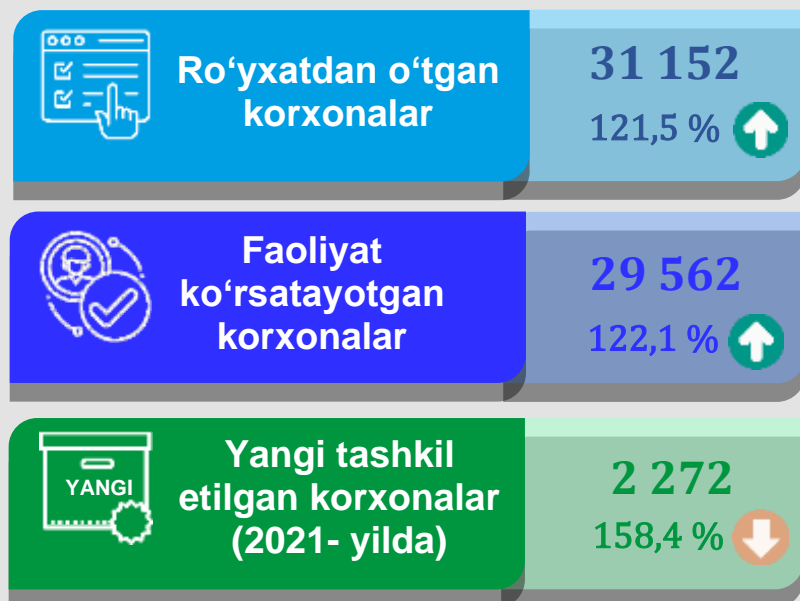

Mamlakatimizda qulay ishbilarmonlik muhitini yaratish va tadbirkorlikni jadal rivojlantirish borasida qator ijobiy o'zgarishlar amalga oshirilmoqda. O'z o'rnida, tadbirkorlik subyektlarini davlat ro'yxatidan o'tkazish va hisobga qo'yish borasida ham qonunchilikda muhim qarorlar qabul qilinib, davlat ro'yxatidan o'tkazish va hisobga qo'yishni avtomatlashtirilgan tizimi bosqichma-bosqich ishlab chiqilib, amaliyotga tadbir qilinmoqda. Bu esa, aholi hamda xorijiy investorlarning o'z shaxsiy biznesini yo'lga qo'yish va rivojlantirish uchun muhim omil bo'lib xizmat qilmoqda.

Faoliyat ko'rsatayotgan korxonalar va tashkilotlar soni

(1- may holatiga ko'ra, birlikda va o'tgan yilga nisbatan o'sish sur'ati bilan)

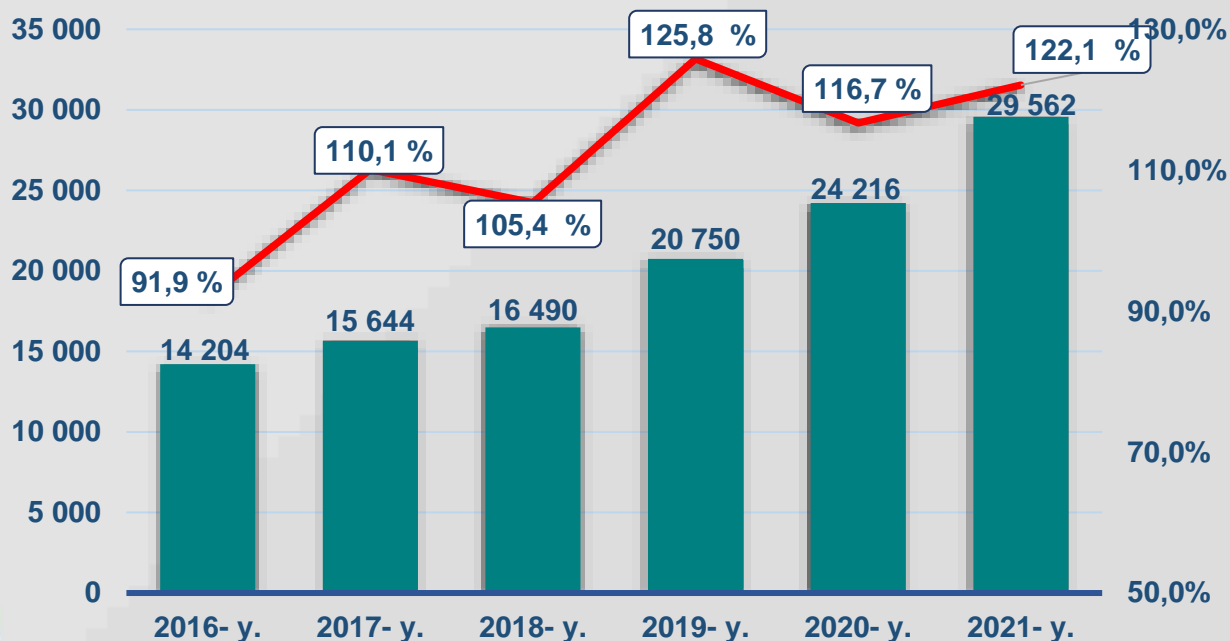

Faoliyat ko'rsatayotgan tijorat korxonalari soni

(tashkiliy-huquqiy shakli bo'yicha
2021- yil 1-may holatiga ko'ra, birlikda)

4

18 945



Mas'uliyati cheklangan jamiyat

3 105



Oilaviy korxonona

137



Unitar korxonona

3 851



Xususiy korxonona

39



Aksiyadorlik jamiyati

179



Boshqa korxonalar

Faoliyat ko'rsatayotgan korxonona va tashkilotlar soni

(iqtisodiy faoliyat turlari bo'yicha 1- may holatiga ko'ra, birlikda)

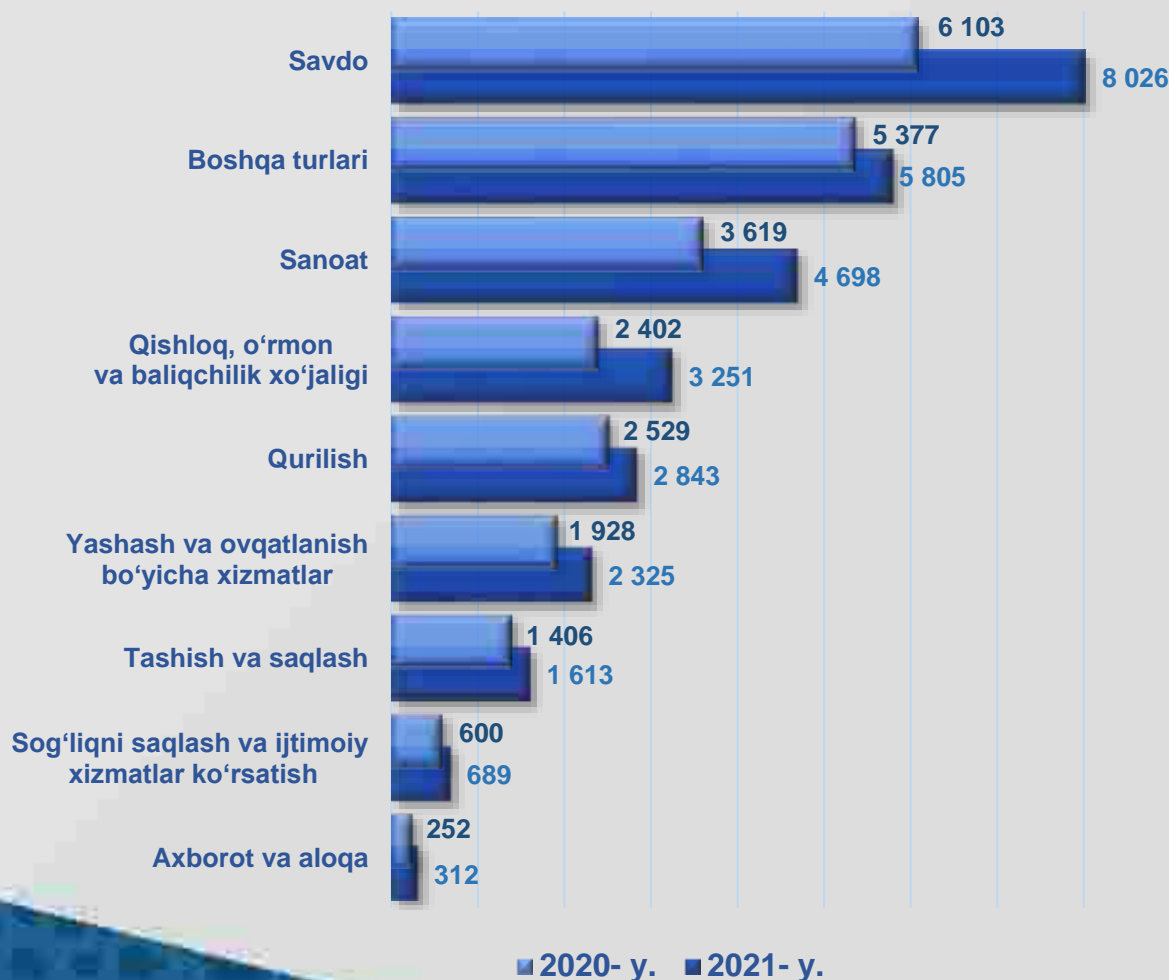

Yangi tashkil etilgan korxonalar va tashkilotlar soni

(iqtisodiy faoliyat turlari bo'yicha, yanvar- aprel oylarida)

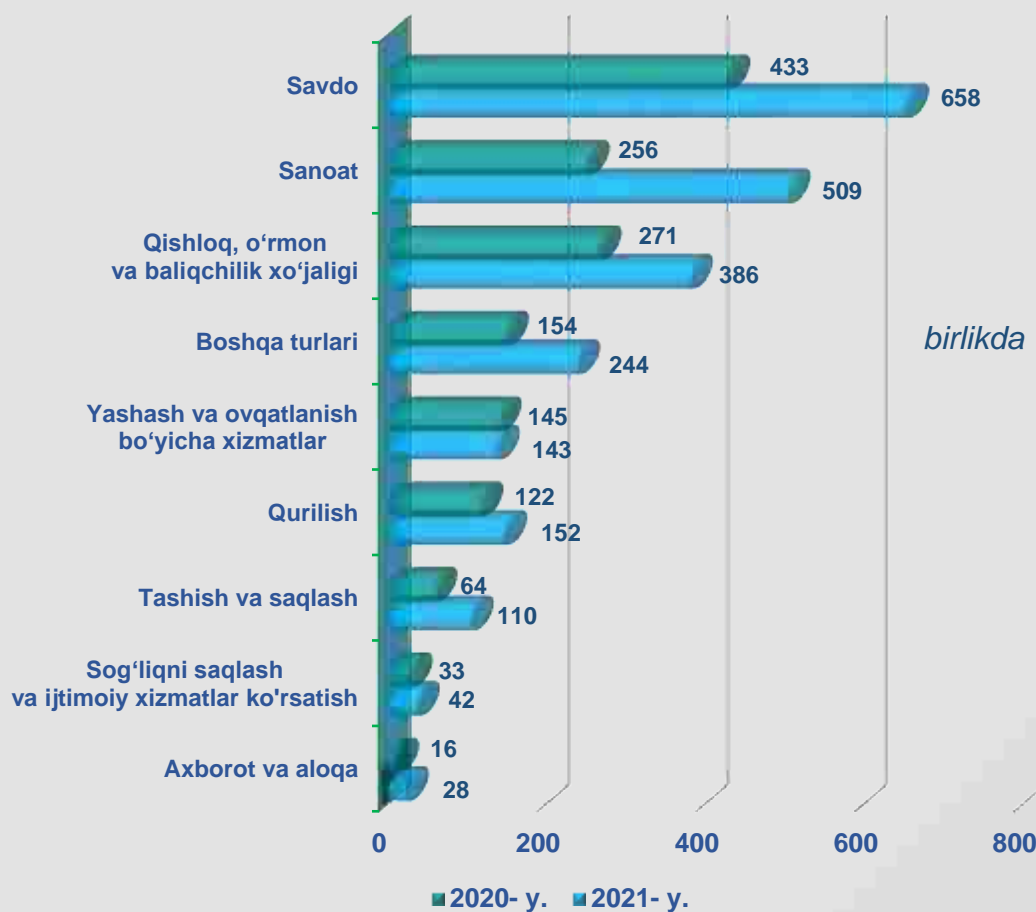

Yangi tashkil etilgan korxonalar va tashkilotlar soni

(yanvar- aprel oylarida, birlikda)

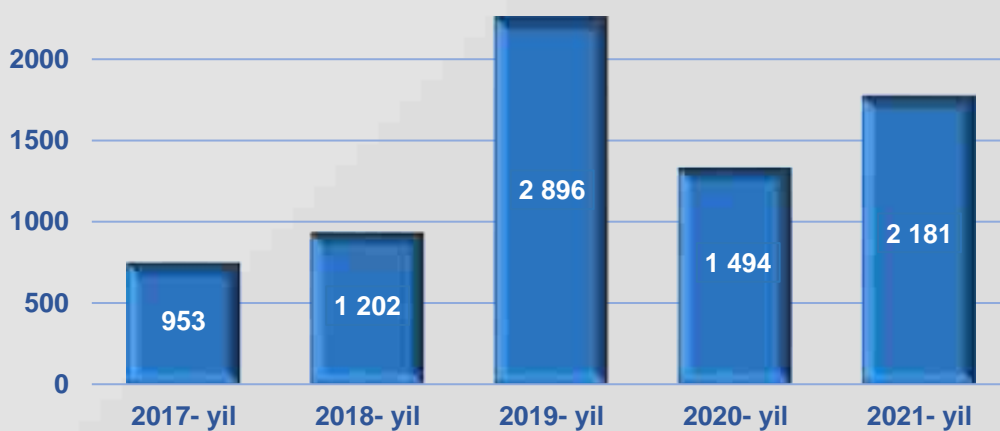

Qishloq, o‘rmon va baliqchilik xo‘jaligida faoliyat ko‘rsatayotgan korxonalar va tashkilotlar

(1- may holatiga ko‘ra, birlikda)



Jami faoliyat ko‘rsatayotgan korxonalar va tashkilotlarning umumiy soni o‘tgan yilning shu davriga nisbatan **35,3** foizga oshdi

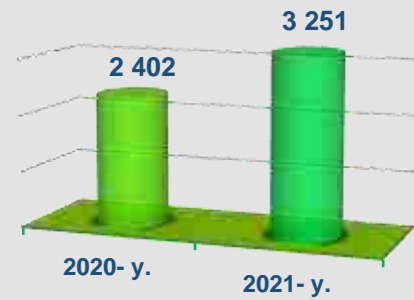

■ Kichik tadbirkorlik subyektlari ■ Mikrofirmalar ■ Kichik korxonalar

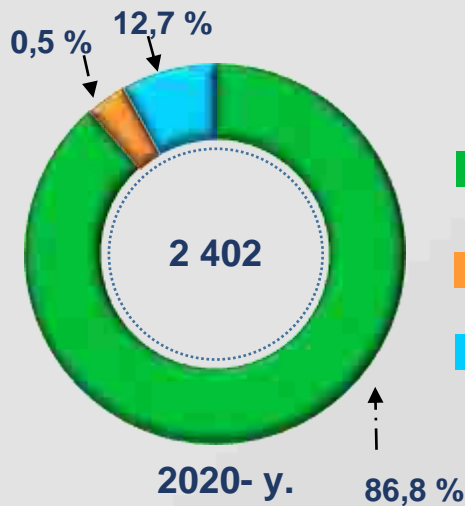
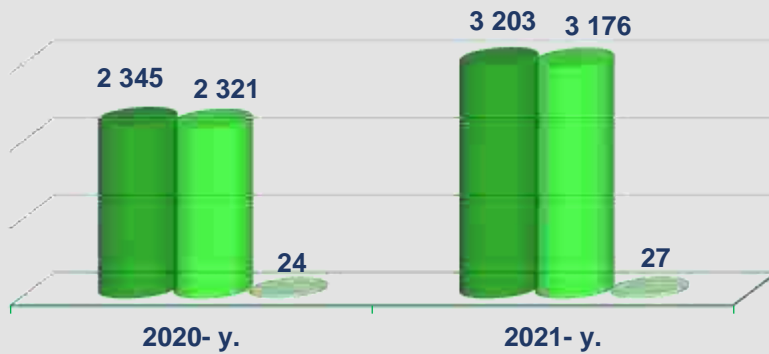

Dehqonchilik, chorvachilik, ovchilik va bu sohalarda xizmat ko‘rsatish
O‘rmon xo‘jaligi
Baliq xo‘jaligi

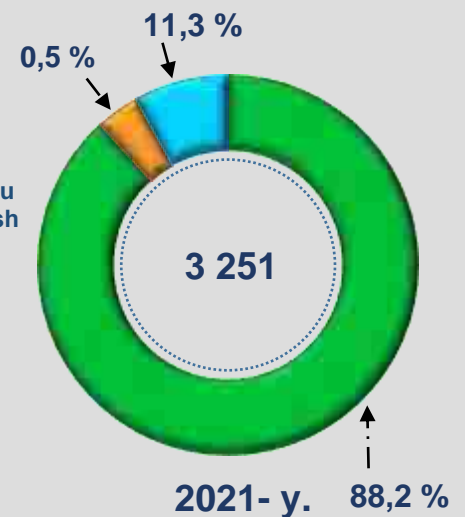

Sanoat yo'nalishida faoliyat ko'rsatayotgan korxonalar va tashkilotlar soni

(2021-yil 1-may holatiga ko'ra, birlikda)



Jami faoliyat ko'rsatayotgan sanoat korxonalar va tashkilotlarning umumiy soni o'tgan yilning shu davriga nisbatan **29,8 foizga oshdi**

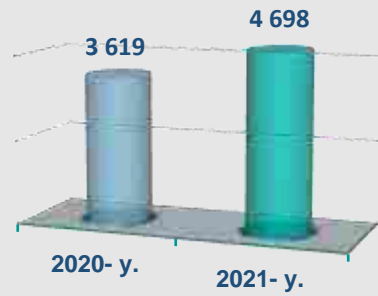

■ Kichik tadbirkorlik subyektlari ■ Mikrofirmalar ■ Kichik korxonalar

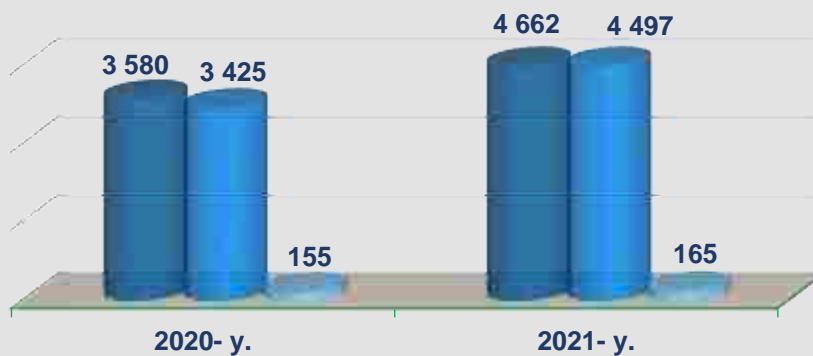

143

Tog'-kon sanoati va ochiq konlarni ishlash

4 455

Ishlab chiqarish sanoati

20

Elektr, gaz, bug' bilan ta'minlash va havoni konditsiyalash

80

Suv bilan ta'minlash, kanalizatsiya tizimi, chiqindilarni yig'ish va utilitatsiya qilish

2021-yil 1-may holatiga ko'ra, sanoat korxonalar va tashkilotlari soni 4 698 tani tashkil etib, o'tgan yilning mos davriga nisbatan 129,8 % ga oshdi.

Jami sanoat korxonalar va tashkilotlari ko'payishining asosiy omili – (o'tgan yilning mos davriga nisbatan), ishlab chiqarish (qayta ishlash) sanoatida – 129,6 % ga (jami sanoatdagi ulushi 94,8 %), tog'-kon sanoati va ochiq konlarni ishlash – 118,2 % ga (jami sanoatdagi ulushi 3,0 %), elektr, gaz, bug' bilan ta'minlash va havoni konditsiyalash – 133,3 % ga (jami sanoatdagi ulushi 0,4 %) va suv bilan ta'minlash, kanalizatsiya tizimi, chiqindilarni utilitatsiya qilishning 177,8 % ga (jami sanoatdagi ulushi 1,7 %) o'sishidir.



Jami faoliyat ko'rsatayotgan korxonalar va tashkilotlarning umumiy soni o'tgan yilning shu davriga nisbatan **12,4 foizga oshdi**

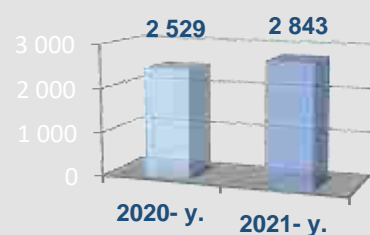

Kichik tadbirkorlik subyektlari soni



12,5 foizga oshdi

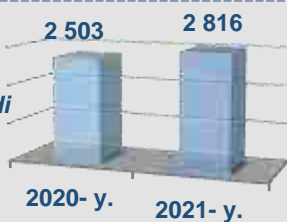

Mikrofirmalar

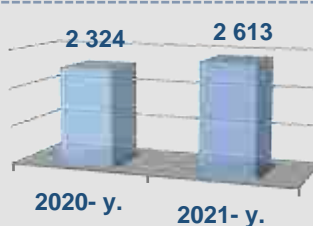

Kichik korxonalar

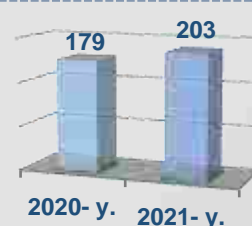

Mas'uliyati cheklangan jamiyatlar

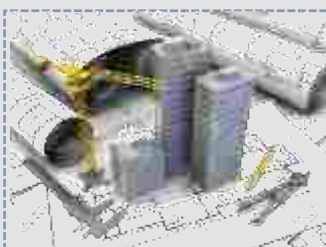

14,7 foizga oshdi

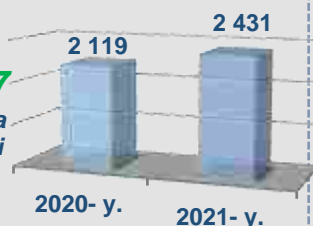

Oilaviy korxonalar



31,3 foizga oshdi

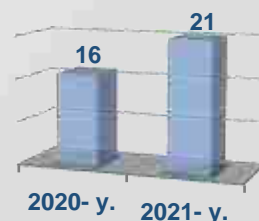

Faoliyat ko'rsatayotgan xorijiy kapital ishtirokidagi korxonalar soni

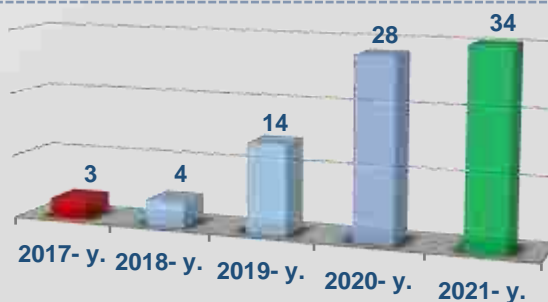

Xususiy korxonalar

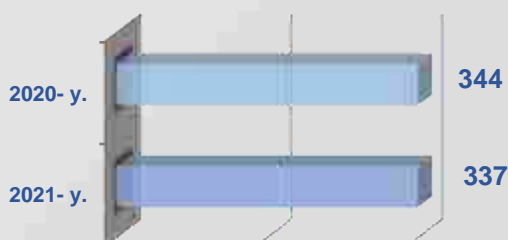

Savdo sohasida faoliyat ko'rsatayotgan korxonalar va tashkilotlar soni

(1-may holatiga ko'ra, birlikda)

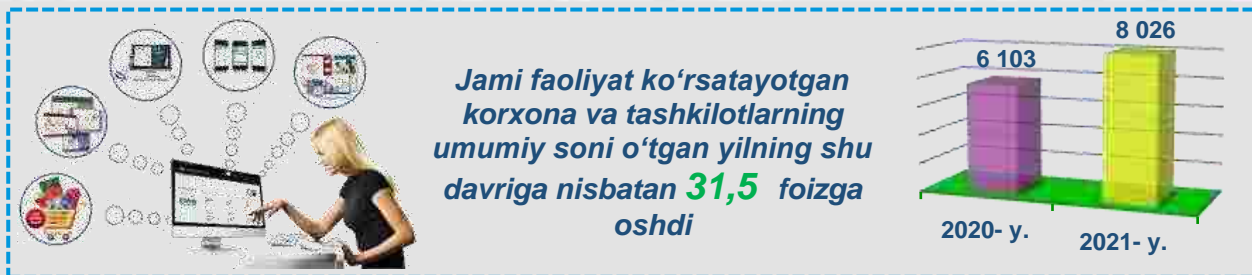

Kichik tadbirkorlik subyektlari soni

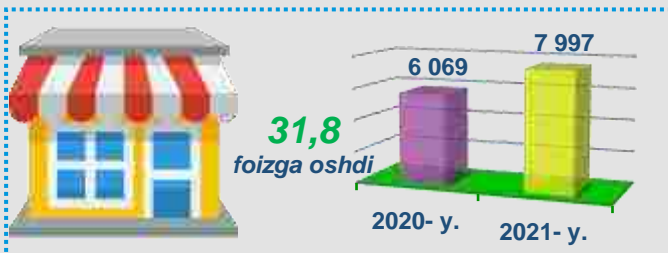

Mikrofirmalar

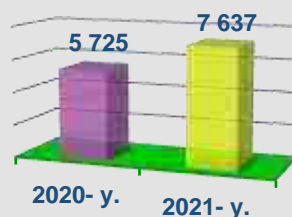

Kichik korxonalar

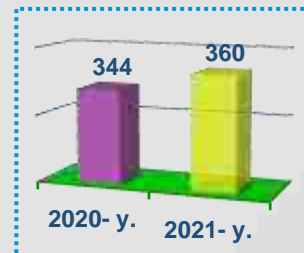

Mas'uliyati cheklangan jamiyatlar

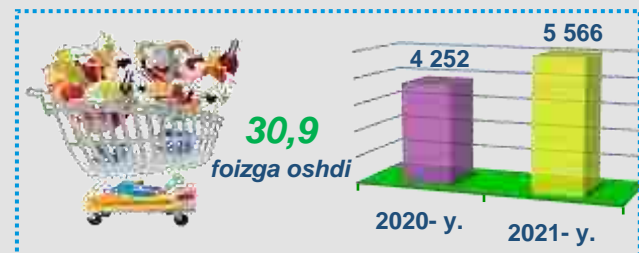

Oilaviy korxonalar

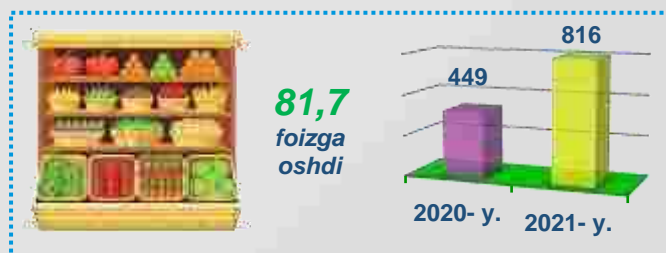

Faoliyat ko'rsatayotgan xorijiy kapital ishtirokidagi korxonalar soni



Xususiy korxonalar

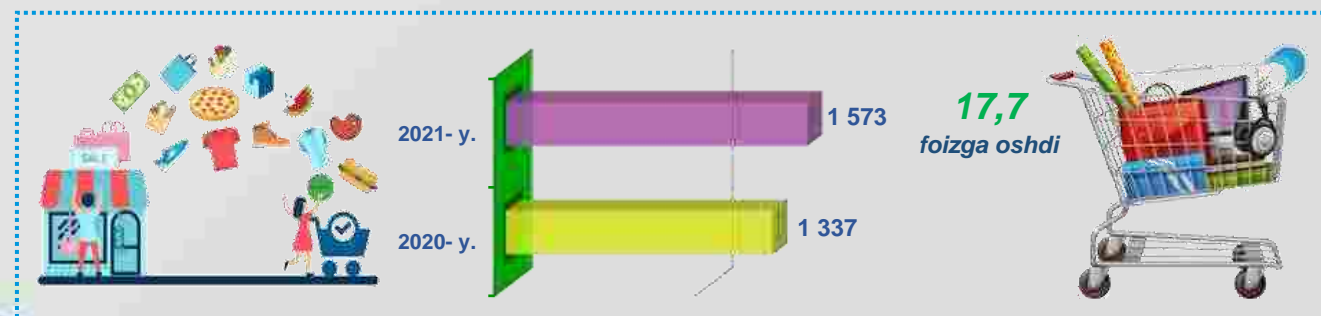

- Sog'liqni saqlash sohasidagi faoliyat

656



- Yashash uchun joy bilan ta'minlangan holda parvarishlash

21



- Yashash uchun joy bilan ta'minlanmagan holda ijtimoiy xizmatlar ko'rsatish

12



Yashash va ovqatlanish bo'yicha xizmatlar sohasida faoliyat ko'rsatayotgan korxonalar va tashkilotlar soni

(2021- yil 1- may holatiga ko'ra, birlikda)



379

yashash bo'yicha xizmatlar



1 946

Oziq-ovqat mahsulotlari va ichimliklar yetkazish bo'yicha xizmatlar

2021- yil 1- may holatiga ko'ra, yashash va ovqatlanish bo'yicha xizmatlar sohasidagi korxonalar va tashkilotlar soni 2 325 tani tashkil etib, o'tgan yilning mos davriga nisbatan 120,6 % ga oshdi.

Jami yashash va ovqatlanish bo'yicha xizmatlar sohasidagi korxonalar va tashkilotlar soni ko'payishining asosiy omili – oziq-ovqat va ichimliklar yetkazish bo'yicha xizmatlar – 124,4 % ga (jami yashash va ovqatlanish bo'yicha xizmatlar sohasidagi ulushi 83,7 %), yashash bo'yicha xizmatlarning- 104,1 % ga (jami yashash va ovqatlanish bo'yicha xizmatlar sohasidagi ulushi 16,3 %) o'sishidir.



Faoliyat ko'rsatayotgan kichik korxonalar va mikrofirmalar soni

(iqtisodiy faoliyat turlari bo'yicha 1- may holatiga ko'ra, birlikda)

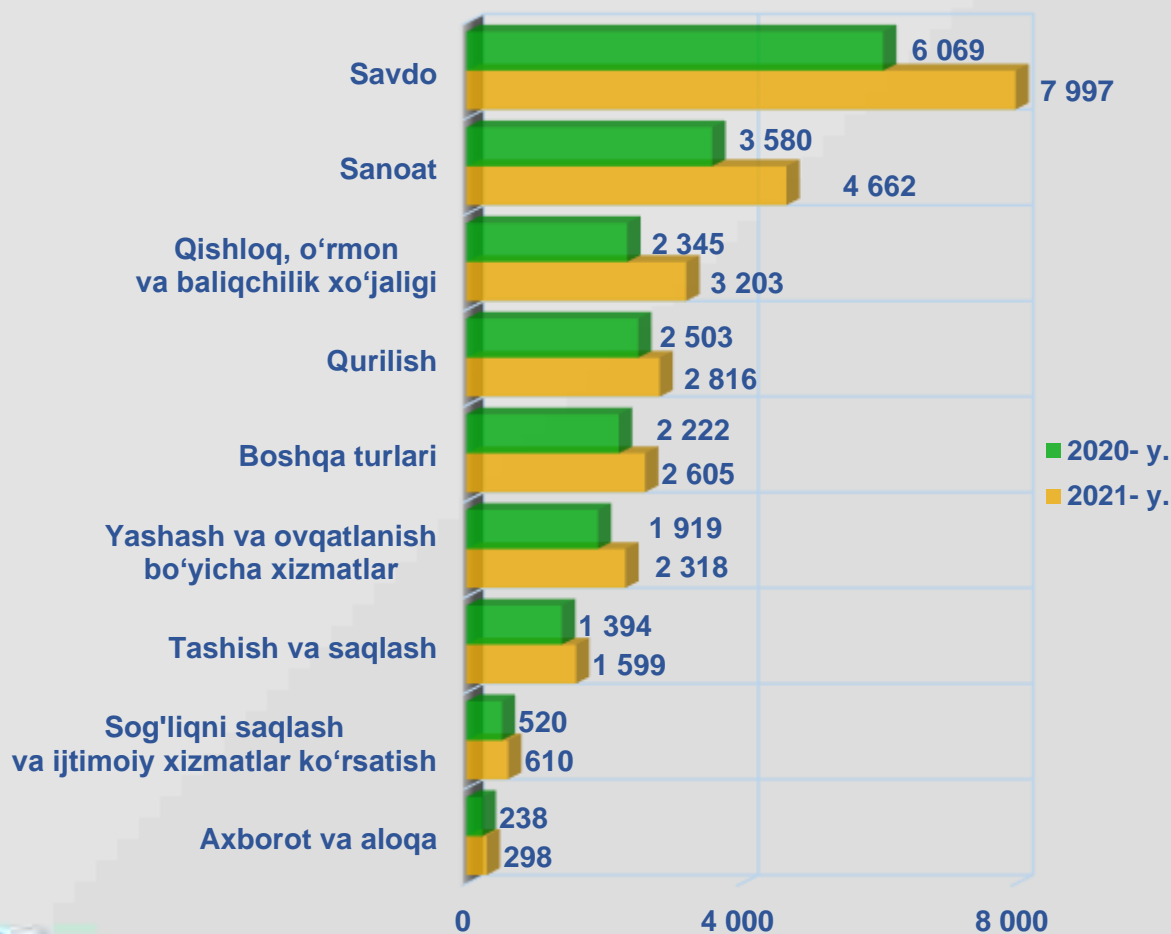

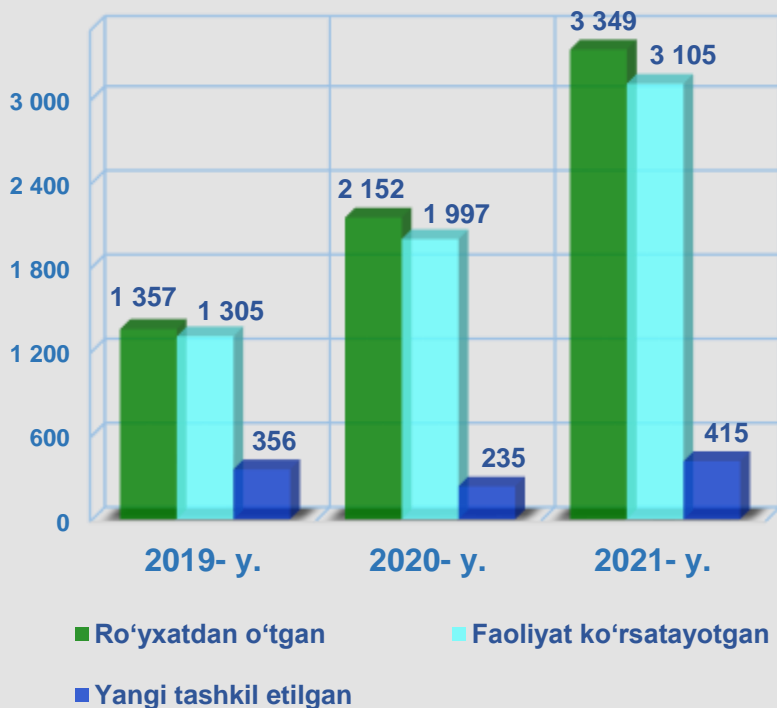

Tashkiliy-huquqiy shakli bo'yicha ro'yxatdan o'tgan oilaviy korxonalar soni 2021- yilning 1- may holatiga ko'ra 3 349 tani tashkil etib, bu ko'rsatkich o'tgan yilning shu davriga nisbatan 1 197 taga yoki 155,6 % ga oshganligini ko'rish mumkin.

Faoliyat ko'rsatayotgan oilaviy korxonalar soni 3 105 tani tashkil etib, bu ko'rsatkich o'tgan yilning shu davriga nisbatan 1 108 taga yoki 155,5 % ga oshganligini ko'rish mumkin.

2021- yilning yanvar- aprel oylarida yangi tashkil etilgan oilaviy korxonalar soni 415 tani tashkil etib, bu ko'rsatkich o'tgan yilning shu davriga nisbatan 180 taga yoki 176,6 % ga oshganligini ko'rish mumkin.

Faoliyat ko'rsatayotgan oilaviy korxonalarining hududlar kesimidagi soni

(2021- yil 1- may holatiga ko'ra, birlikda)

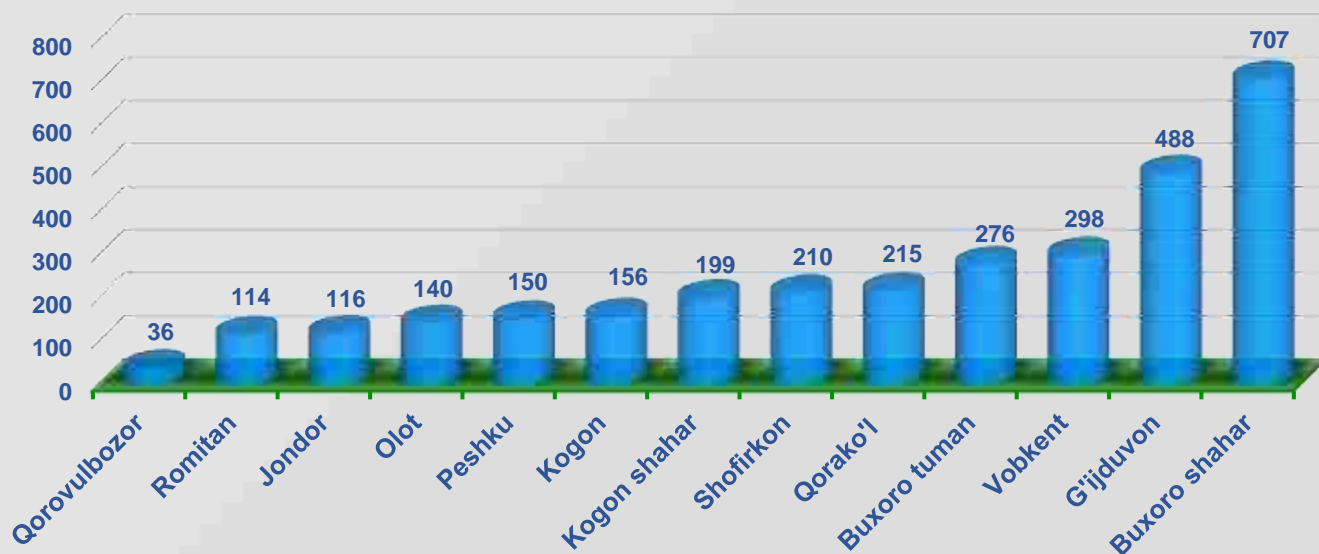

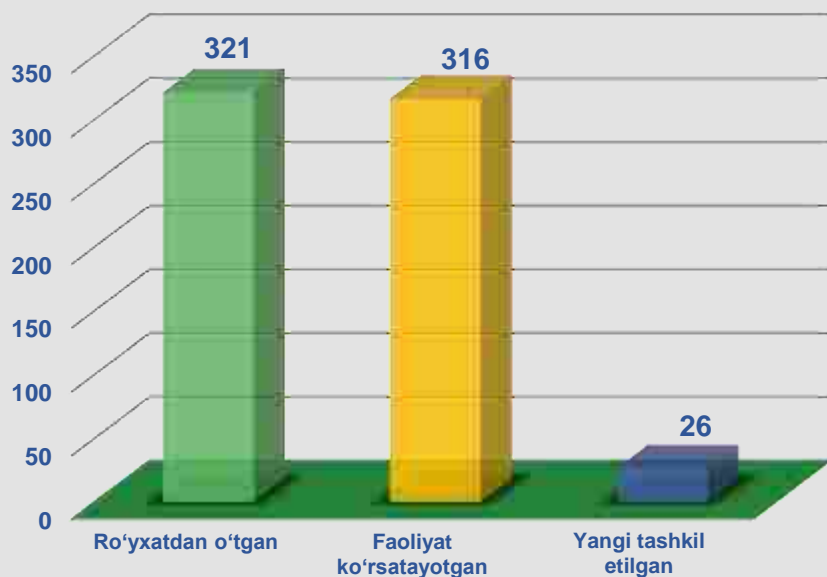

Ro'yxatdan o'tgan xorijiy kapital ishtirokidagi korxonalar va tashkilotlar soni 2021- yil 1- may holatiga ko'ra 321 tani tashkil etib, ulardan 316 tasi yoki 98,4 % faoliyat ko'rsatmoqda. Bu ko'rsatkich o'tgan yilning shu davriga nisbatan olganda 25 taga yoki 108,4 % ga oshganligini ko'rish mumkin.

2021- yilning yanvar- aprel oylarida viloyatimizda 26 ta xorijiy kapital ishtirokidagi korxonalar va tashkilotlar yangi tashkil etildi.

Yangi tashkil etilgan xorijiy kapital ishtirokidagi korxonalar soni

(iqtisodiy faoliyat turlari bo'yicha yanvar- aprel oylarida, birlikda)

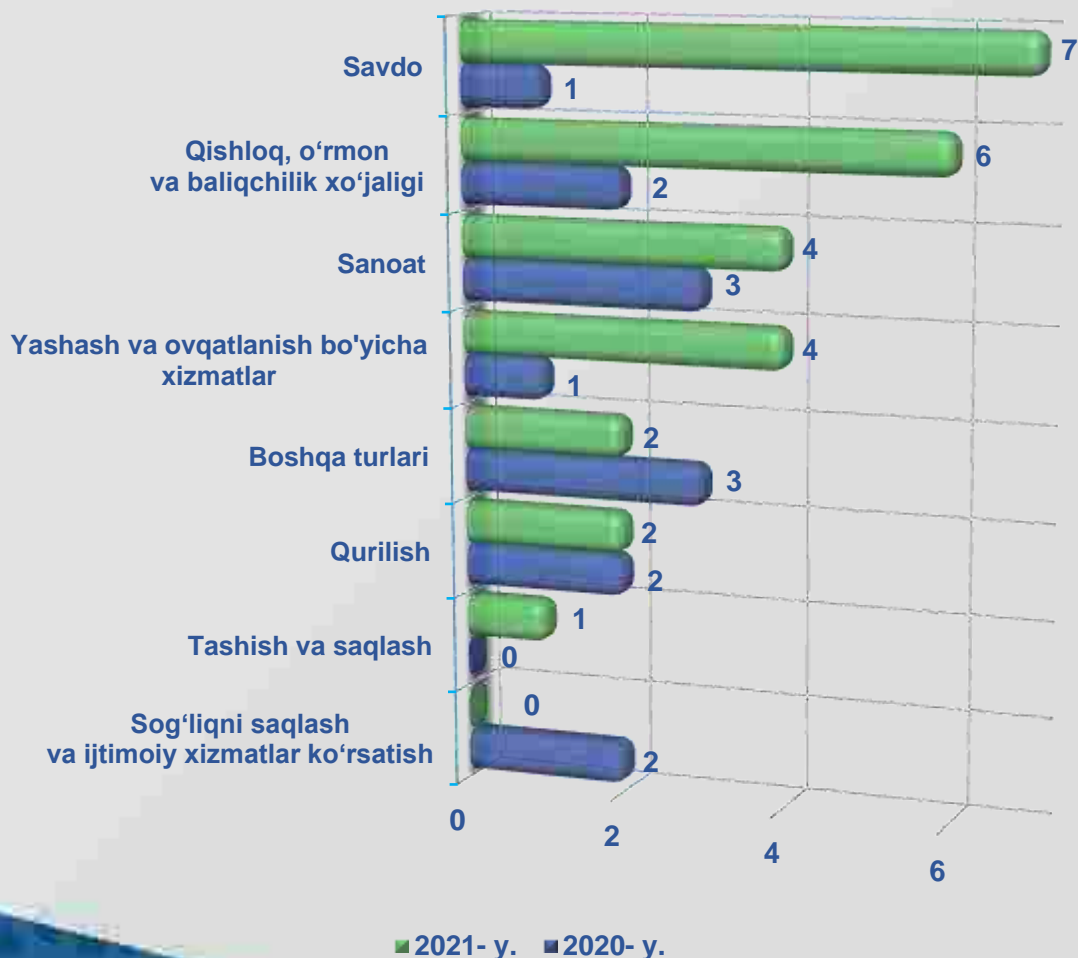

Xorijiy kapital ishtirokidagi faoliyat ko'rsatayotgan korxonalarining davlatlar kesimida soni

(2021- yil 1- may holatiga ko'ra, birlikda)

14

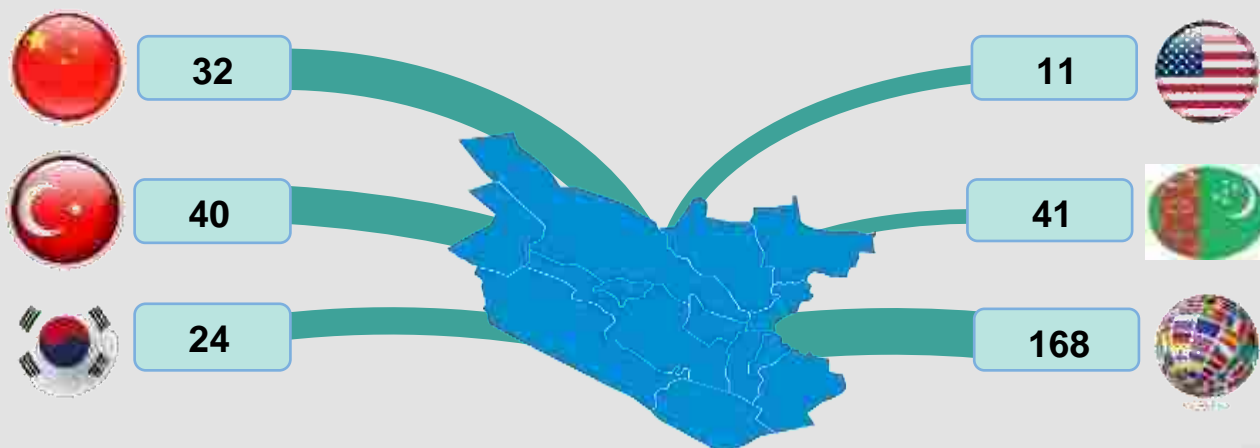

Faoliyat ko'rsatayotgan xorijiy kapital ishtirokidagi korxonalar soni

(iqtisodiy faoliyat turlari bo'yicha 1- may holatiga ko'ra, birlikda)

	2017- yil	2018- yil	2019- yil	2020- yil	2021- yil
Jami	81	100	207	286	316
<i>shu jumladan:</i>					
Qishloq, o'rmon va baliqchilik xo'jaligi	1	3	17	20	28
Sanoat	54	59	97	122	124
Qurilish	3	4	14	28	34
Savdo	11	17	38	59	72
Tashish va saqlash	-	-	2	6	5
Yashash va ovqatlanish bo'yicha xizmatlar	6	7	17	23	23
Axborot va aloqa	1	-	1	1	1
Sog'liqni saqlash va ijtimoiy xizmatlar ko'rsatish	1	1	4	6	6
Boshqa turlar	4	9	17	21	23

Hududlar kesimida xorijiy kapital ishtirokidagi faoliyat ko'rsatayotgan korxonalar soni (2021- yil 1- may holatiga ko'ra, birlikda)

	Jami	<i>shundan:</i>	
		qo'shma korxonona	xorijiy korxonona
Viloyat bo'yicha	316	157	159
Buxoro shahar	164	73	91
Kogon shahar	13	9	4
<i>tumanlar:</i>			
Olot	7	-	7
Buxoro	15	11	4
Vobkent	6	3	3
G'ijduvon	11	8	3
Kogon	29	20	9
Qorako'l	7	3	4
Qorovulbozor	11	4	7
Peshku	19	7	12
Romitan	12	5	7
Jondor	14	9	5
Shofirkon	8	5	3

Xorijiy kapital ishtirokidagi faoliyat ko'rsatayotgan korxonalarning asosiy qismi Buxoro shahrida 164 ta (umumiy miqdoridagi ulushi 51,9 %), Kogon tumani 29 ta (9,2 %), Peshku tumani 19 tani (6,0 %), Kogon shahar 13 ta (4,1 %), Buxoro tumani 15 ta (4,7 %), hamda Jondor tumanlarida 14 tani (4,4 %) tashkil etadi.

Hududlar kesimida jami xorijiy kapital ishtirokidagi korxonalarning qo'shma korxonalar va xorijiy korxonalar taqsimlanishi (2021- yil 1- may holatiga ko'ra, jamiga nisbatan ulushi, % da)

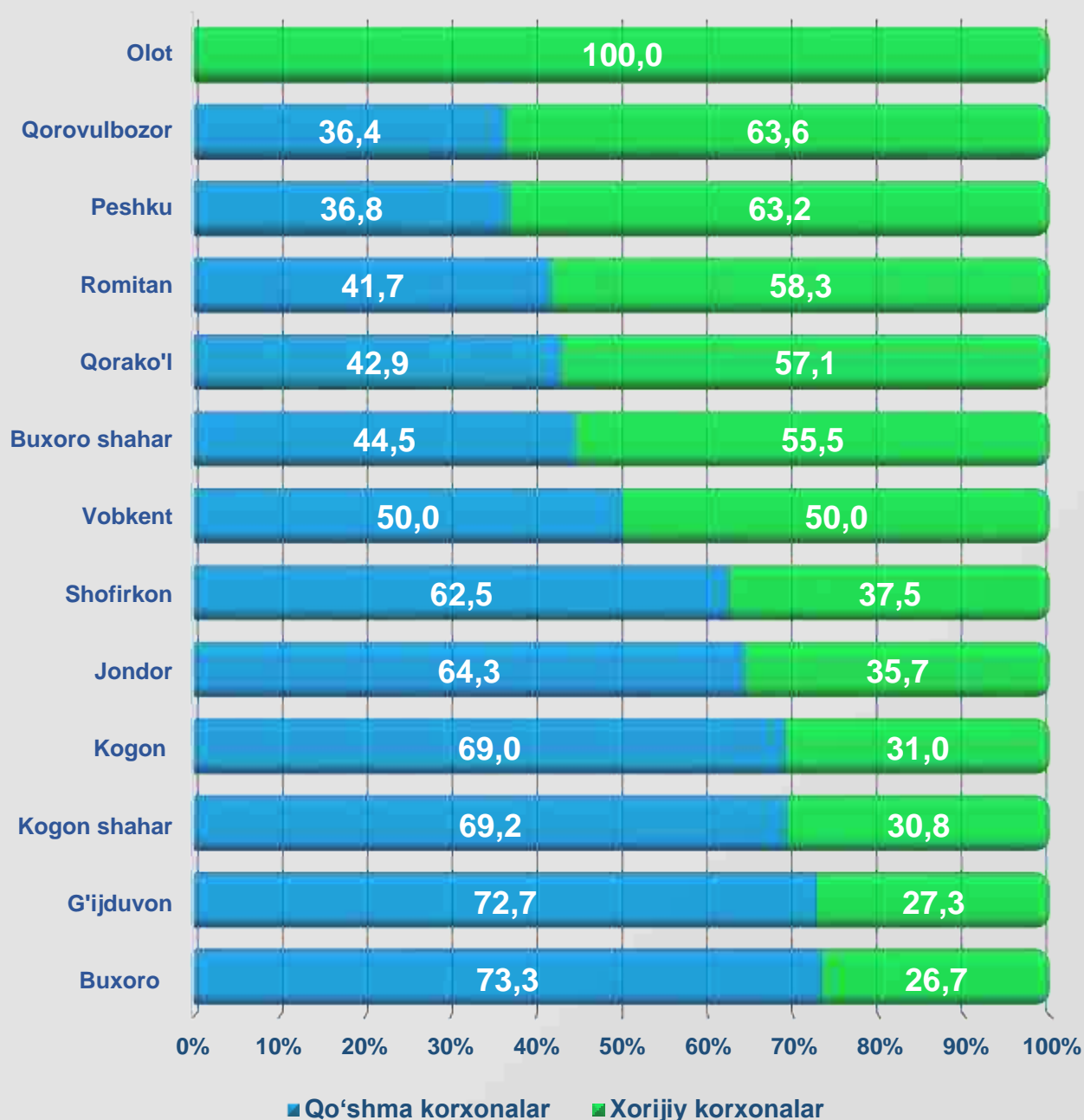

2017-2021- yillarda rivojlanishning beshta ustuvor yo'nalishi bo'yicha "Harakatlar strategiyasi"ning uchinchi muhim yo'nalishi - xalqaro iqtisodiy hamkorlikni yanada rivojlantirish hisoblanadi. Xorijiy investitsiyalar ishtirokidagi korxonalar sonini o'sib borishi, eng avvalo, mamlakatdagi siyosiy barqarorlik va investitsiya faoliyatining qonuniy asoslari takomillashib borayotgani bilan izohlanadi.

Ro'yxatdan o'tgan korxonalar va tashkilotlarning hududlar bo'yicha soni

(2021- yil 1- may holatiga ko'ra, birlikda)



2021- yil 1- may holatiga ko'ra, ro'yxatdan o'tgan korxonalar va tashkilotlar hududlar kesimida taqsimlanganda ularning ulushi Buxoro shahri (29,2 %), G'ijduvon(10,7%), Romitan(8,2 %), Buxoro (7,8 %), Jondor (6,6 %), Peshku (6,1 %), Shofirkon(6,0 %), Kogon (5,2 %), Qorako'l (5,2 %), Vobkent (5,0 %), Kogon shahar (4,1 %), Olot (3,5 %), Qorovulbozor (2,3 %) tumani hissalariga to'g'ri keladi.

Yangi tashkil etilgan korxonalar va tashkilotlarning hududlar bo'yicha soni

(2021- yil yanvar- aprel oylarida, birlikda)

2021- yilning yanvar- aprel oylarida yangi tashkil etilgan korxonalar va tashkilotlar hududlar kesimida taqsimlanganda, ularning soni Buxoro shahri (24,0 %), G'ijduvon(9,9 %), Buxoro (9,0 %), Romitan (9,2 %), Peshku (6,2 %), Kogon (5,1 %), Jondor (8,3 %), Vobkent (6,3 %), Shofirkon (6,6 %), Qorako'l (4,7 %), Olot (4,5 %), Qorovulbozor (2,6 %) tumanlari va Kogon shahar (3,3 %), ulushiga tegishli.

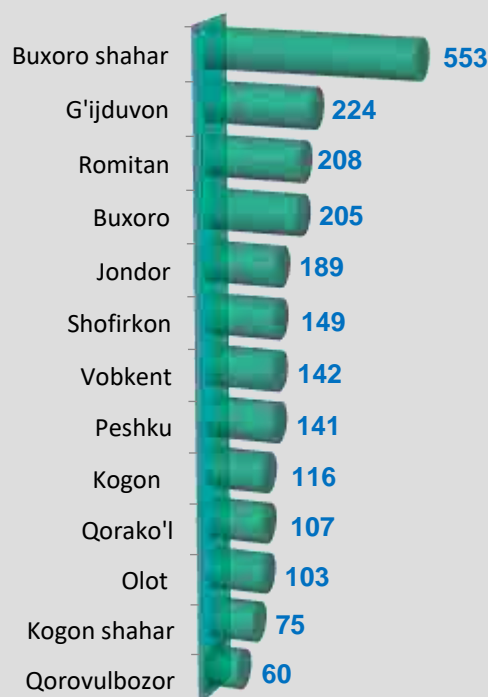

Faoliyat ko'rsatayotgan kichik korxonalar va mikrofirmalarning hududlar kesimidagi soni

(2021- yil 1- may holatiga ko'ra, birlikda)

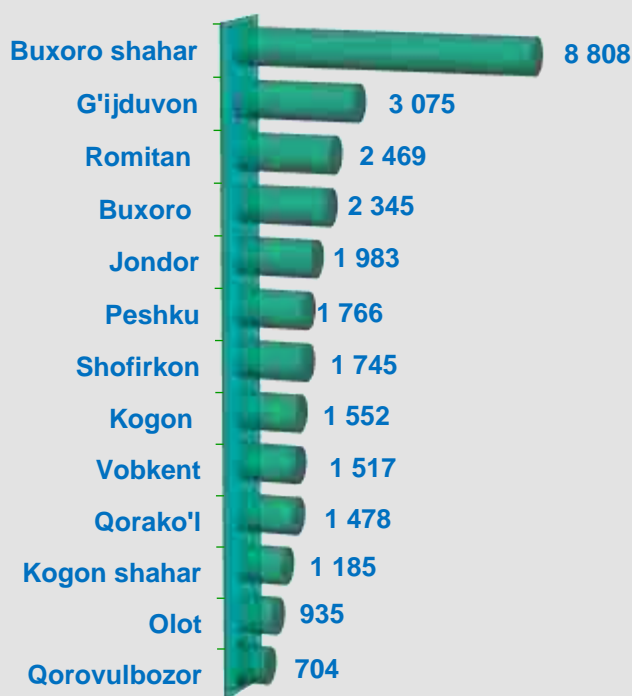

2021- yil 1- may holatiga ko'ra, faoliyat ko'rsatayotgan kichik korxonalar va mikrofirmalar hududlar kesimida taqsimlanganda ularning ulushi, Buxoro shahri (33,7 %), G'ijduvon(11,8 %), Romitan (9,5 %), Buxoro (9,0 %), Jondor (7,6 %), Peshku (6,8 %), Shofirkon (6,7 %), Kogon (5,9 %), Vobkent (5,8 %), Qorako'l (5,7 %), Kogon shahar (4,5 %), Olot (3,6 %), Qorovulbozor (2,7 %) tumani hissalariga to'g'ri keladi.

Hududlar kesimida yangi tashkil etilgan kichik korxonalar va mikrofirmalar soni

(2021- yilning yanvar- aprel oylarida, birlikda)

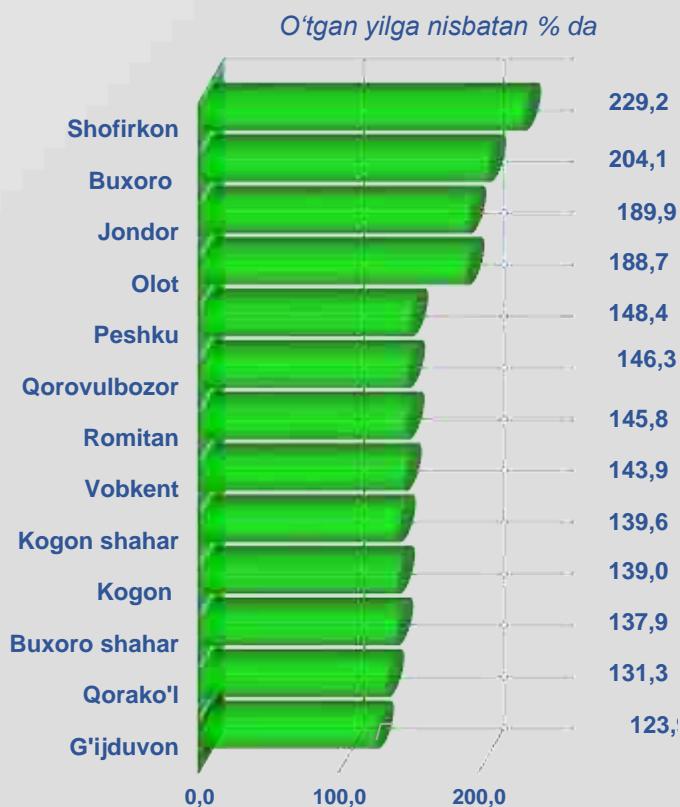
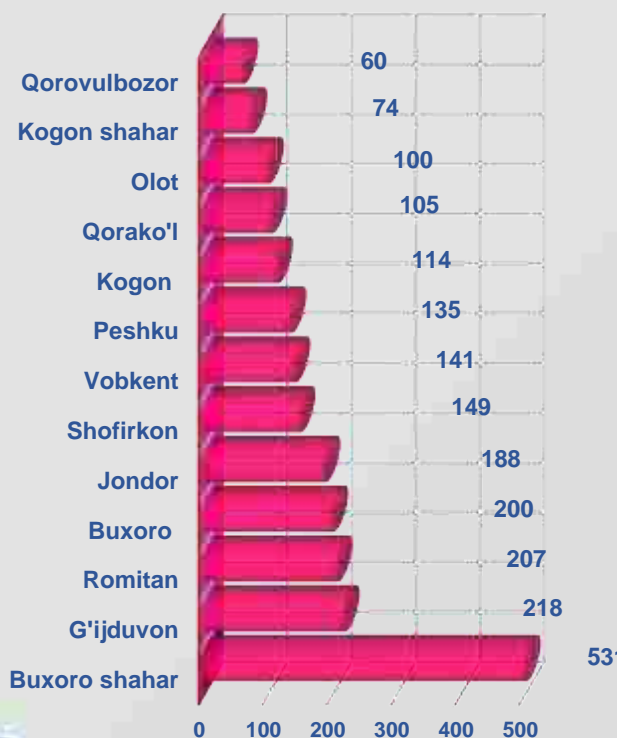

Statistik ko'rsatkichlarga izohlar

Korxonalar va tashkilotlarning yagona davlat registri – axborot ma'lumotnoma tusidagi, vaqti-vaqti bilan yangilab boriladigan ma'lumotlardan iborat bo'lgan avtomatlashtirilgan tizim hisoblanadi hamda yagona klassifikatsiyalar tizimi asosida korxonalar va tashkilotlarning davlat hisobini va ularni identifikatsiyalashtirishni ta'minlaydi.

Ro'yxatga olingan korxonalar va tashkilotlar – ro'yxatdan o'tkazish organlari tomonidan belgilangan tartibda davlat ro'yxatidan o'tkazilgan hamda yuridik shaxslarning davlat reestrda mavjud bo'lgan yuridik shaxslardir (faoliyati tugatilgan yuridik shaxslardan tashqari).

Faoliyat ko'rsatayotgan korxonalar va tashkilotlar – ro'yxatdan o'tkazish organlari tomonidan belgilangan tartibda davlat ro'yxatidan o'tkazilgan hamda davlat statistika organlariga moliya-xo'jalik faoliyatini amalga oshirmayotganligi yoki tugatish jarayonida ekanligi to'g'risidagi ma'lumot kelib tushmagan yuridik shaxslardir.

Yangi tashkil etilgan korxonalar va tashkilotlar – ro'yxatdan o'tkazish organlari tomonidan belgilangan tartibda, yuridik shaxslarning davlat reestriga yangidan kiritilgan yuridik shaxslardir.

Kichik korxonalar va mikrofirmalar – O'zbekiston Respublikasi Vazirlar Mahkamasining 2016-yil 24-avgustdagi "Iqtisodiy faoliyat turlarini tasniflashning xalqaro tizimiga o'tish chora-tadbirlari to'g'risida" 275-son qarorining 1-ilovasiga muvofiq, kichik tadbirkorlik subyektlariga ajratiladi.

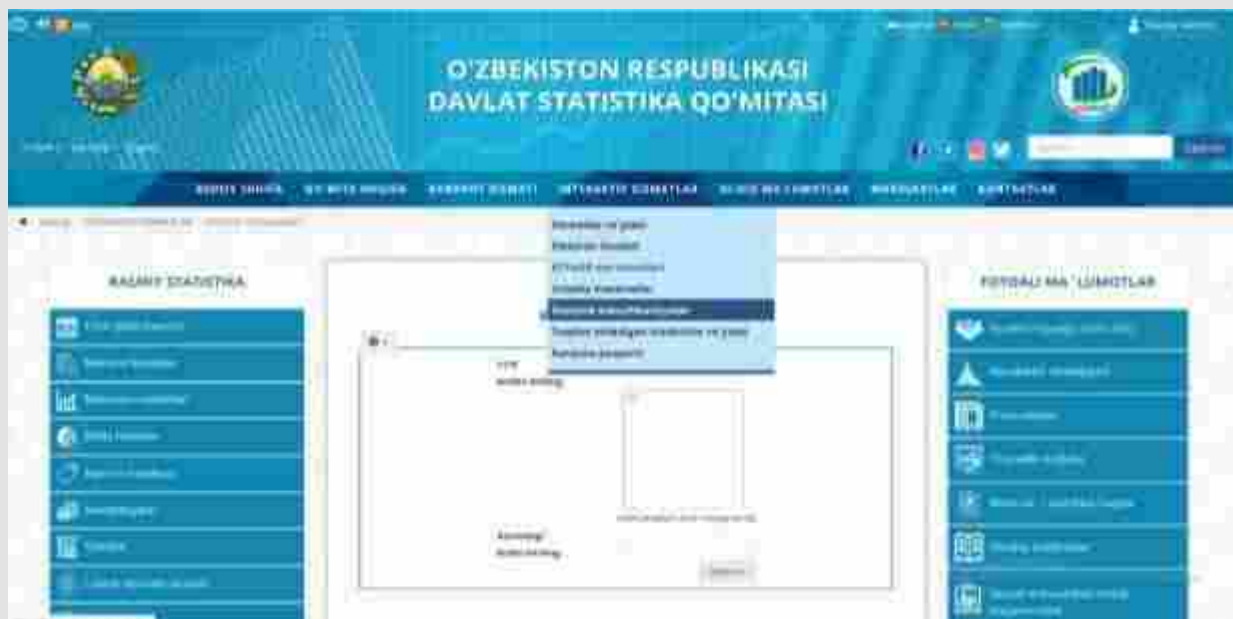

Tashqi foydalanuvchilar, bevosita Davlat statistika qo'mitasining www.stat.uz rasmiy saytida real vaqt rejimida, so'ralayotgan yuridik shaxsning (STIR) kodini kiritib, axborotlarni bepul olishlari mumkinligi belgilab qo'yilgan.

Buxoro viloyati
Statistik registrlarni yuritish bo'limi
Tel.: (65) 223-83-20